

The Best Water Partner

NARBO 3<sup>rd</sup> General Meeting, 22 February 2008, Solo Indonesia

# K water's Collaboration Activity in the Citarum River Basin

*Dr. Ick Hwan Ko*  
*Director*  
*K water Research Center*



## *Water Issues in the Citarum Basin*

### ● Citarum Basin (Indonesia)

= Han River Basin (Korea)?

● As the M&I water demands are increasing, water pollution in the Canal will adversely affect

-> stable water supply to JKT Metropolitan, and

-> sustainable management of the Citarum basin!

### ● Need for Participatory IWRM Approach!

- sound technological base & capacity building

- public awareness on water issues in the Citarum

# *PDA Project Description*

## Title

- *Development of a Water Quality Management System for the West Tarum Canal of Citarum River Basin in West Java Province*

## Period

- December 5, 2006 ~ December 4, 2007

## Object

- To pilot an approach through systematic monitoring of water quality and the development of a system to support better water quality management in the context of Integrated Water Resources Management (IWRM) of the CRB

## Support

- Asian Development Bank (ADB)

## Project Team

- Korea Water Resources Corporation (K water)
- Jasa TirtaII Public Corporation (PJTII)

# Project Team (K water)

Roles	Name and Position
Project Manger	Dr. Ick Hwan Ko Director of K water Research Center
Water Quality Management Specialist	Dr. Jeongkon Kim Principal Researcher
Water Quality Modeling Specialist	Dr. Joonwoo Noh Senior Researcher
Water Quality Monitoring Specialist	Dr. Sangyoung Park Senior Researcher
Water Quality Specialist	Mr. Sang Uk Lee Researcher

# Project Team (PJT II)

Roles	Name and Position
Project Leader	Herman Idrus, CES Head of Planning Bureau
Water Quality Modeling Specialist	Erni Murniati, M.Sc Staff Planning Bureau
Monitoring Specialist	Udien Yulianto, M.Tech Staff Laboratory and Engineering Consultancy Services Unit
Hydraulic / Hydrology Engineer	Resky Heraveno ST Staff Division I



# Project Area

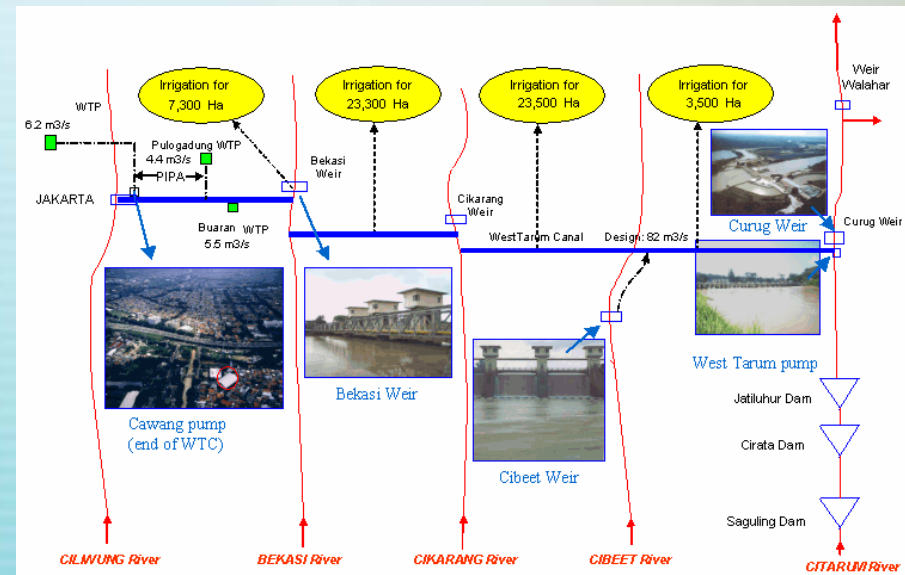
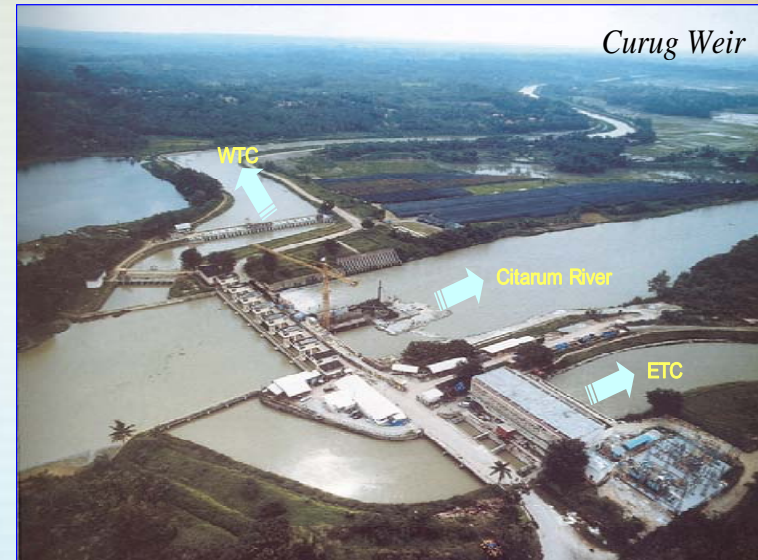
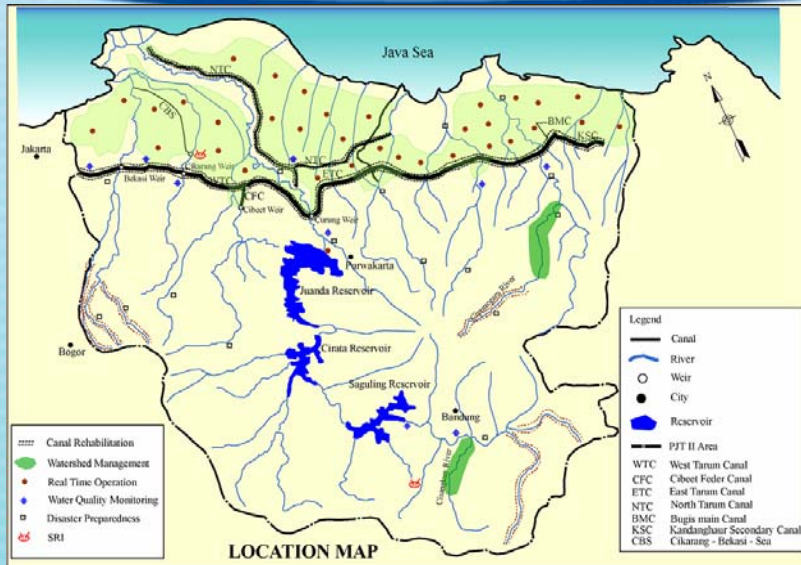

# Work Plan/ Project Progress

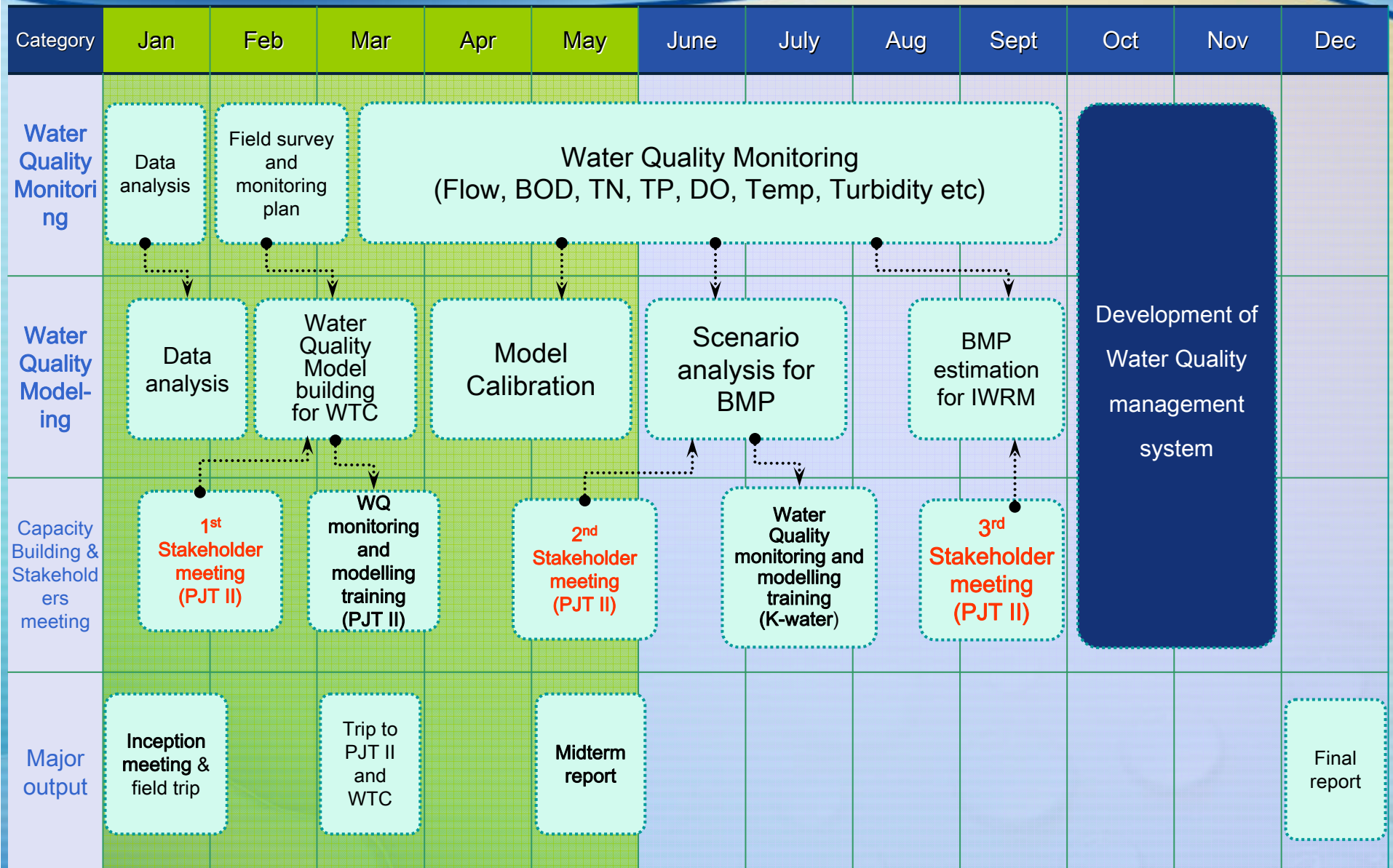



# WQ Monitoring Network Design

- Total 11 Sampling Points
- Flow rate, and 11 Water Quality Constituents
- BOD, COD, DO, Temp, N, and P-Groups

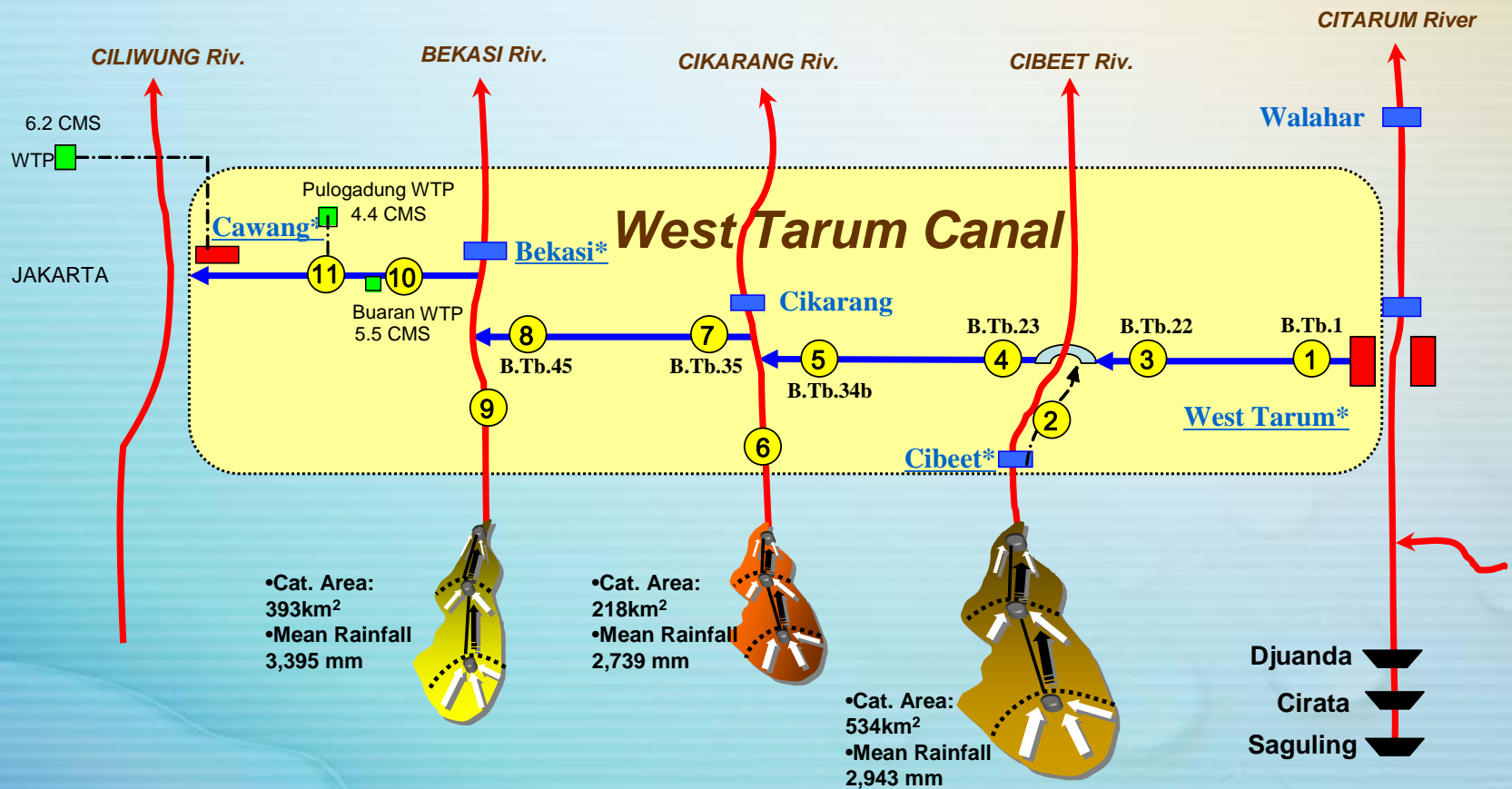



# Progress of Project

WQ Monitoring

WQ  
Modeling

Capacity  
Building

Stakeholders'  
Participation

- QUAL2E-Plus is used for WQMS
- QUEAL2E-Plus: Steady-state, Non-uniform flow model
  - Developed by K-water based on QUAL2E
  - Advanced GUI for easy input & output data manipulation
  - Developed under .NET Framework environment



# Result of Model Run

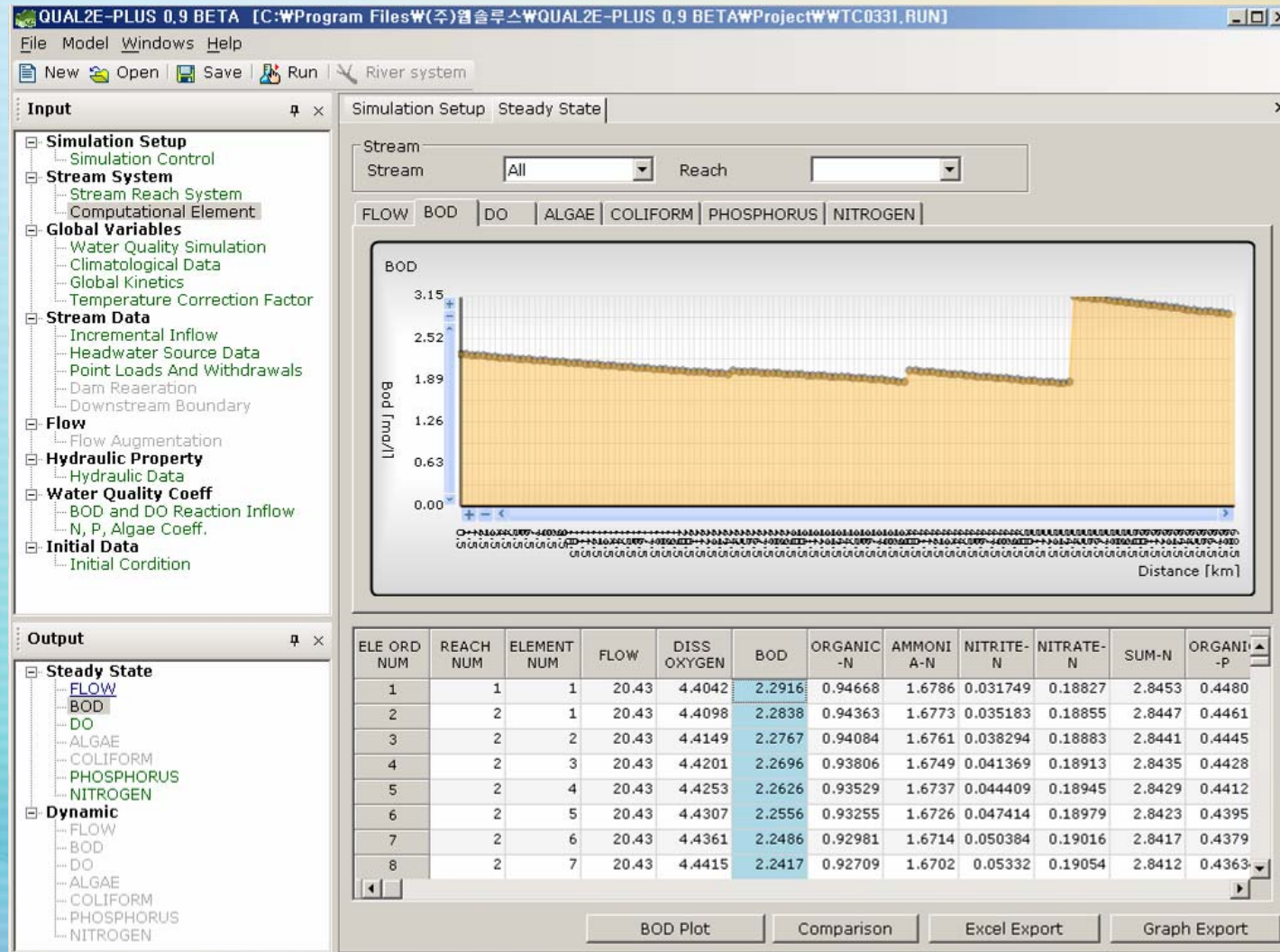

# Scenario development

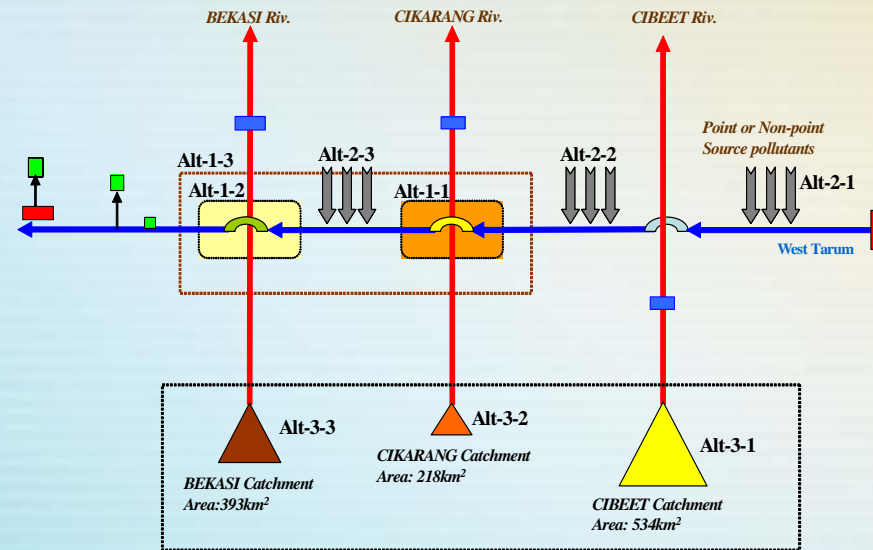

Alt-1: local resources separation using siphon  
 Alt-2: reducing pollutant sources along the canal  
 Alt-3: water quality improvement in the tributaries

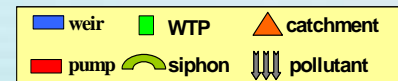

- ALT-1: Local resources separation using siphon
- ALT-2: Non-point source management
- ALT-3: Water quality improvement in the tributaries



# *Inception Meeting (30 Jan 2007)*

- Discussion on a detailed work plan for project implementation
- Participants from ADB, Indonesian NARBO, PJT II, and Kwater



# 1<sup>st</sup> Stakeholders' Meeting

- on 23 March 2007 in Jartiluhur in Indonesia
- 8 organizations shared ideas, knowledge, & experience wrt the PDA Project





# *Institutional Capacity Building*

- DG of Water Res Dev., Ministry of Public Works and President Director of PJT II visited Kwater for institutional capacity building from 14th to 18th of May 2007





## 2<sup>nd</sup> training session in Korea in July 2007



- 6 project staffs from PJT II visited K-water for institutional for capacity building from July 26 to 20, 2007.
- The Indonesian staffs visited the water resources operation center of K-water and exchanged their concerns and experiences about water-related issues in both countries especially on water quality management.

## *Obtained Outputs from the Project*

- A comprehensive **water quality monitoring network** for WTC
- **Water quality database** (BOD, DO, Turbidity, TN, TP, etc.) based on the adequate monitoring activities
- A sound **water quality modeling system** for WTC
- **Increased capacity** of PJT II and stakeholders in water quality monitoring and modeling technology
- **Increased public awareness** on water quality issues
  - stakeholder participation & interaction

## *Three Key Factors to Consider to Attain IWRM Solutions*

- Legal / political institutional setting
- Sound technical knowledge base
- Public involvement and consensus building

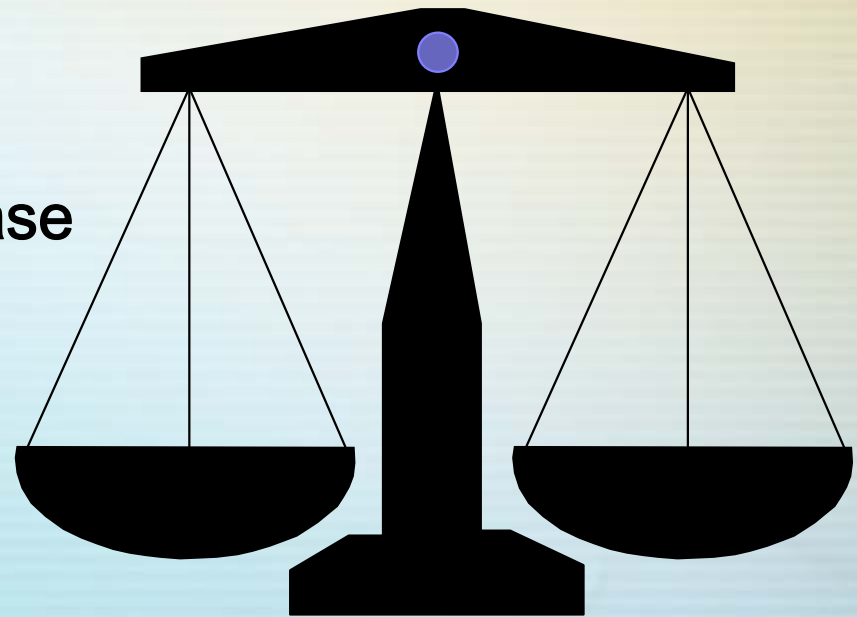



# Water Quality Management System

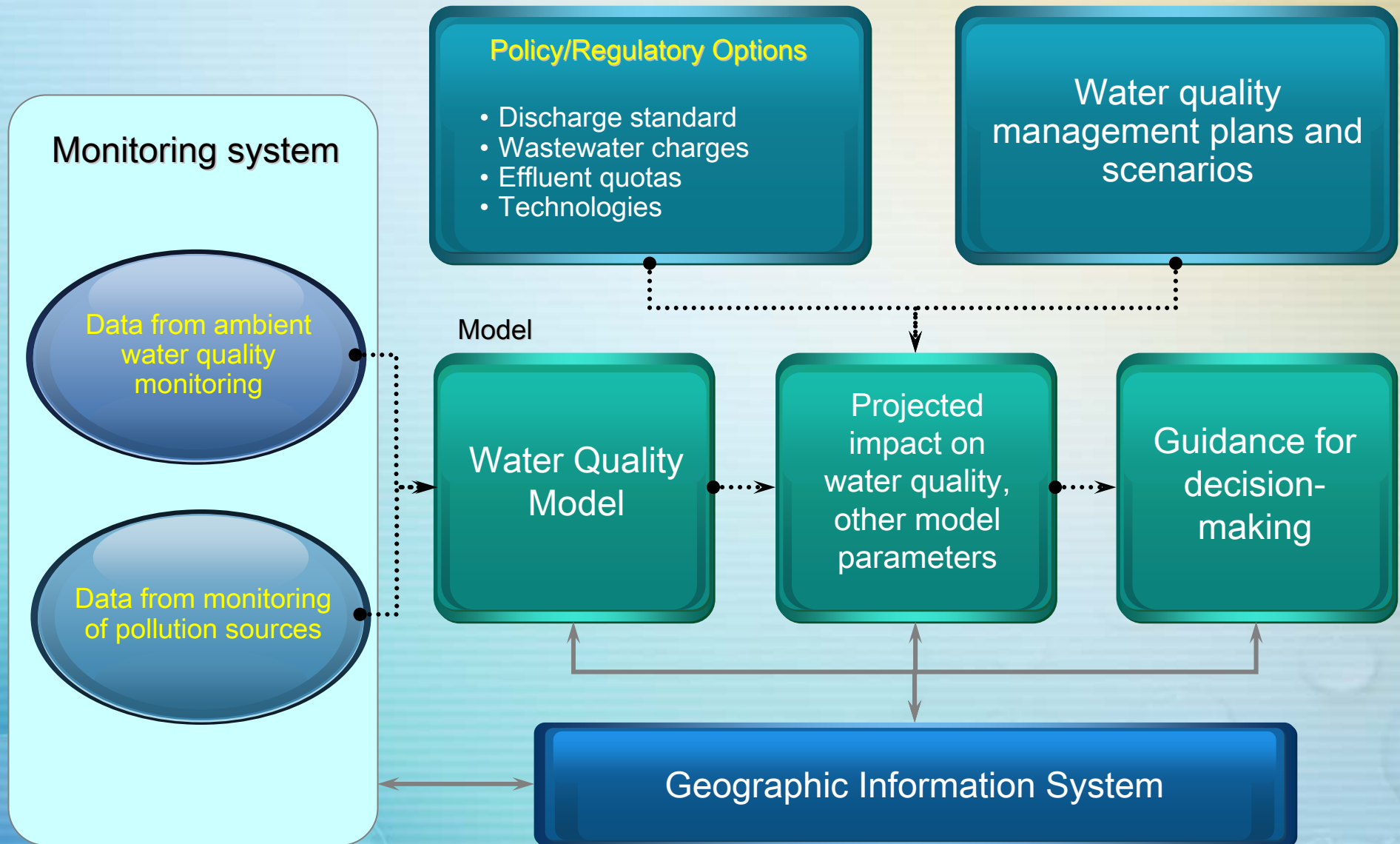

# *How to use the developed System?*

- The system will serve for water quality management in the context of IWRM of the CRB!
  - compiling hydrologic/hydraulic data,
  - conducting water quality monitoring/evaluation & prediction
  - promoting collaboration among the Citarum basin water managers, national/local stakeholders & the public
- Establishment of basic strategies and BMP -  
for sustainable environmental and water resources management applicable for the WTC area
  - [and later for the whole CRB]

# *How to prepare for the Citarum basin?*





Strategy & Action Plans to establish IWRM  
in the CRB

IWRM for WTC (PDA)

K-water

PJT II &  
Stakeholders

TEAM WORK

ADB

GOI

*A Proposal for*

***NARBO/APWF Knowledge Hub***

***Workshop on***

***basin water quality management***

# *Trainings offered Previously*

## ➤ **NARBO's 3<sup>rd</sup> Training Workshop on IWRM**

➤ 14 – 18 November 2005, Daejeon, Korea

➤ Topic: "Technology for IWRM – River Basin Approach"

➤ Participants:

25 from RBOs of NARBO member countries

➤ Main objective:

To share experiences of developing and applying technologies for Integrated River Basin Water Resource Management among Asian countries



# Opening Session



Management (IWRM) - RIVE  
2005 Co-organized by NARBO and KOWACO in Collabora



The Best Water Partner



# Leadership Workshop on Integrated Water Resources Management

- Jointly organized by K-water and UNESCAP
- 17-20 September 2007
- Participants:
  - 15 government officials working in water resource management from 9 Asian countries
- Main objective :
  - To enhance leadership for the efficiency and sustainability of water resources management at the national level



# Leadership Workshop on Integrated Water Resources Management



The Best Water Partner



# *A Proposal for workshop on water quality management*

*river basin*

- Background
  - The Asia-Pacific Water Forum (APWF) was launched in 2006 to improve sustainable water management
  - A new approach of Knowledge Hubs was suggested for countries with advanced expertise and existing centers of excellence in the region to offer their services as regional water knowledge hubs
  - At the regional consultation meeting in Singapore in October 2007, Kwater was designated as the candidate **Regional Water Knowledge Hub for Water Quality Management in River Basins**.
  - As a part of the activities for the knowledge hub and 2008-2009 NARBO, Kwater proposes a workshop with the main theme of 'integrated river basin water quality management' under the concept of IWRM.

- **Expected date**
  - 3 days in September 2008
- **Location**
  - Korea Institute of Water and Environment (KIWE) in K-water, Daejeon, Korea
- **Expected Participants**
  - 25 people (including 20 Trainees and 10 Invited Speakers/ Lecturers)

- **Main Issues to be covered:**

- **Lectures**

- Role of water quality management in IWRM
- Integrated River-Reservoir water quality management
- Model applications

- Hands-on Practice with steady and unsteady water quality models developed by K water

- On site training

- Field Trip to Geum River Basin

- Individual & Group Discussion



# Thank You!!



# *How to promote the IWRM Process?*

## **Open & Transparent Process**

- **Common Assumptions & Estimates of Management Strategies**
- **Common Data**
- **Common Analytical Tools**

## **Functions**

- **National/Regional Water Planning**
- **Water-related Conflict Resolution**
- **Various Trade-off Analysis**



 **Final Goal : Mutual Trust & Consensus Building**

## *How to promote IWRM Process? (Need for Collaborative Leadership)*

- If you bring the appropriate people together in constructive ways with good information, you can create authentic SHARED VISIONs and STRATEGIES for addressing and implementing IWRM in the whole Citarum basin!
- Based on SOUND TECHNOLOGY and Multi-sectoral/ muti-disciplinary Participatory Approach!

# Integrated Real-time Water Resources Management System (IRWMS)

